

Installation manual

M Floor To Ceiling Mount Pro D-Series MBFC1UD

EAN:7350073737734

- eng Installation manual
- ar تثبيت الجدار
- cz Instalační manuál
- da Installationsmanual
- de Installationsanleitung
- ee Paigaldusjuhend
- el Οδηγίες εγκατάστασης
- es Manual de instalación
- fi Asennusohje
- fr Installation Manuel
- he הנקתה ךירדמ
- hu Szerelési kézikönyv
- it Manuale di installazione
- jp 取り付け説明書
- kr 설치 설명서
- li Montavimo instrukcija
- lt Uzstādīšanas rokasgrāmata
- nl Installatie handleiding
- no Installasjonshåndbok
- pl Instrukcja instalacji
- pt Manual de instalação
- ro Manual de instalare
- ru Инструкция по установке
- sk Inštaláčny manuál
- sl Navodila za montažo
- sv Installationsmanual
- tr Montaj kılavuzu
- zh 安装手册

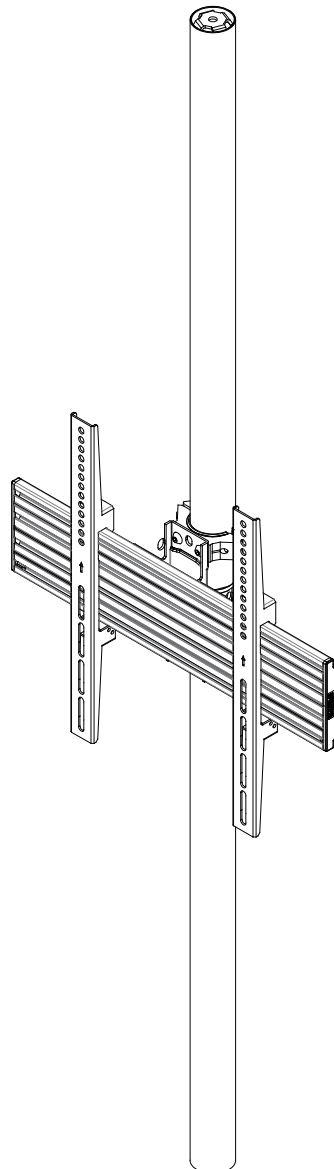

en **IMPORTANT!**
Your Plasma, LCD, TV, Projector, Projector Screen or other HiFi equipment represents a considerable value.
If screws are included they may not be suitable for the material of your wall, ceiling or floor. Replace the screws with suitable ones if needed.
In case you are unsure regarding any aspects of the mounting of this product please Consult a professional.

ar **أهم!**
إن شاشة البلازما أو LCD أو التلفاز أو جهاز العرض أو شاشة جهاز العرض أو أجهزة هاي فاي الأخرى أجهزة ذات قيمة عالية.
إن كانت البراغي مرفقة، فقد لا تكون مناسبة لمادة الجدار أو السقف أو الأرضية.
عند الحاجة لبراغي أخرى مناسبة إذا لزم الأمر.
حالة عدم إتمامك بأي جزئية من جزئيات تركيب هذا المنتج، يرجى استشارة فني متخصص.

cz **DŮLEŽITĚ!**
Váš plazmový nebo LCD televizor, projektor, plátno a další elektrotechnické vybavení je vysoce hodnotné.
Pokud jsou součástí balení produktu šrouby, zkontrolujte, zda jsou vhodné pro upevnění ke stěně, stropu nebo podlaze v místě instalace.
V případě, že nebudou přibalené šrouby vyhovovat, vyměňte je.
Pokud budete mít při montáži tohoto produktu potíže, obraťte se na zkušeného odborníka.

da **VIGTIGT!**
Din plasmaskærm, LCD-skærm, tv, projektor, projektorskærm eller andet HiFi-udstyr repræsenterer en betydelig værdi. Hvis der medfølger skruer, passer de muligvis ikke til materialet i væggen, loftet eller gulvet. Udskift skruerne med passende skruer, hvis det er nødvendigt.
Hvis du er i tvivl om noget i forbindelse med monteringen af produktet, skal du kontakte en ekspert.

nl **BELANGRIJK!**
Uw Plasma, LCD TV, Projector, Projector scherm of andere HiFi-apparatuur vertegenwoordigt een aanzienlijke waarde.
Het kan zijn dat de bijgeleverde schroeven niet geschikt zijn voor uw toepassing. In dat geval dient u ze te vervangen door schroeven die wel geschikt zijn. Twijfelt U, raadpleeg dan een professional.

ee **TÄHTIS!**
Teie teler, projektor, projektori ekraan või muu HiFi seade on suure väärtusega.
Kui kinnitused on komplektis paigalduskruvid, siis ei pruugi need sobida Teie sein, lae või põranda materjaliga. Vajadusel vahetage kruvid sobivate vastu.
Kui Te ei ole seadme paigaldamise detailides kindel, siis konsulteerige spetsialistiga.

de **ACHTUNG!**
Ihr Plasma-, LCD-, TV-Gerät, Ihr Projektor, Ihre Leinwand oder sonstige HiFi-Ausrüstung stellt einen beträchtlichen Wert dar. Die möglicherweise im Lieferumfang enthaltenen Schrauben sind unter Umständen nicht für das Material Ihrer Wände, Decken oder Böden geeignet. Ersetzen Sie sie bei Bedarf durch geeignete Schrauben.
Wenn Sie bezüglich der Montage des Produkts unsicher sind, wenden Sie sich an einen Fachman

el **ΣΗΜΑΝΤΙΚΟ!**
Οι τηλεοράσεις Plasma, LCD, α κανονικές τηλεοράσεις, οι οθόνες προβολέων ή άλλες συσκευές HiFi έχουν μία αξιοσημείωτη αξία. Αν περιλαμβάνονται βίδες ίσως να μην είναι κατάλληλες για το υλικό του τοίχου, του ταβανιού ή του πτώμστός σας. Αντικαταστήστε τις βίδες με κατάλληλες αν είναι απαραίτητο.
Στην περίπτωση που δεν είστε σίγουροι για κάποιες ζητήματα σχετικά με την προάρθρωση αυτού του προϊόντος, παρακαλούμε συμβουλευτείτε έναν ειδικό.

es **IMPORTANTE!**
Los equipos de plasma o LCD, los televisores, proyectores y pantallas de proyección, así como otros equipos de alta fidelidad suponen una inversión considerable. Si incluyen tornillos, puede que no sean adecuados para el material del que están formados la pared, el techo o el suelo. Sustituya estos tornillos por otros más adecuados si es preciso.
Si no está seguro sobre cualquier aspecto del montaje de este producto, consulte a un profesional.

fi **TÄRKEÄÄ!**
Plasma- tai nestekidenäyttöjen, televisioiden, projektorien ja niiden valkokankaiden sekä muiden hi-fi-laitteiden arvo on huomattava. Laitteen mukana toimitettavat ruuvit eivät välttämättä sovellu seinien, katon tai lattian materiaaliin. Korvaa ne tarvittaessa sopivilla ruuveilla.
Mikäli olet epävarma mistä tahansa tämän tuotteen kiinnittämisessä liittyvästä seikasta, ota yhteys asiantuntijaan.

fr **IMPORTANT!**
Vos écrans plasma, LCD, télévisions, projecteurs, écrans de projection ou autre matériel Hi Fi ont une valeur considérable. Les vis fournies peuvent ne pas être compatibles à la nature de vos murs, plafonds et sols. Remplacez-les par des vis adaptées.
Si vous avez des doutes quant au montage de ce produit, veuillez consulter un professionnel.

hu **FONTOS!**
Plazma, LCD TV-d, projektorod, vetítővásznad vagy egyéb műszaki berendezéseid tekintélyes értéket képvisel. Ha a csavarokat tartalmazza, akkor sem biztos, hogy alkalmas a berendezés, hogy falra, mennyezetre, vagy a padlóhoz rögzítsd. Cseréld ki a csavarokat a megfelelőre, ha szükséges. Abban az esetben, ha nem biztos a termék beépítésével kapcsolatosan, forduljon szakemberhez.

it **IMPORTANT!**
I vostri plasma, LCD, TV, proiettori, schermi di proiezione o altri apparecchi Hi-Fi rappresentano un notevole investimento. Le viti in dotazione potrebbero rivelarsi non adatte per il materiale della parete, del soffitto o del pavimento. Sostituitele quindi con viti più idonee in caso di necessità.
Nel caso riscontrate problemi nel montaggio di questo prodotto, consultate un tecnico specializzato.

jp **重要!**
あなたのプラズマ、LCDは、テレビ、プロジェクタ、プロジェクタースクリーンまたは他のハイファイ機器はかなりの値を表します。
ネジが含まれている場合、彼らはあなたの壁、天井や床の材質に適していないかもしれませんが。
必要に応じて適切なものでネジを取り付けます。
ケースでは、本製品の取り付けのいずれかの側面に不明な点があるプロに相談してください。

no **VIKTIG!**
Din plasma, LCD, TV, projektor, projektorskjerm eller annet HiFi-utstyr har betydelig verdi. Hvis skruer følger med, er det ikke sikkert at de passer til materialet i veggen, taket eller gulvet. Bytt skruene i skruer som er egnet om nødvendig.
Hvis du er usikker når det gjelder montering av dette produktet, må du kontakte en profesjonell.

pl **UWAGA!**
Monitor plazmowy, LCD, telewizor, projektor, ekran projekcyjny lub inny sprzęt HiFi stanowi znaczną wartość. Jeśli dołączono do niego śruby mocujące, mogą one nie być odpowiednie do materiału, z którego wykonane są dane ściany, sufit lub podłoga. W razie potrzeby należy je zastąpić odpowiednimi śrubami.
W razie jakichkolwiek wątpliwości dotyczących montowania tego urządzenia należy zasięgnąć porady u specjalisty.

pt **IMPORTANT!**
O seu Plasma, LCD, TV, projetor, tela de projeção ou outro equipamento de HiFi representa um valor considerável.
Se os parafusos estão incluídos eles podem não ser adequados para o material da sua parede, teto ou chão.
Substitua os parafusos com os adequados, se necessário.
Em caso de dúvida sobre quaisquer aspectos da montagem deste produto, consulte um profissional.

li **SVARIGI!**
Jūsu Plasma, LCD, TV, projektor, projektora ekrāns vai cita HiFi iekārta veido ievērojamu vērtību.
Iekārtās skrūves var būt nepiemērotas jūsu sienu, griestu vai grīdas materiāliem. Nomainiet skrūves ar piemērotām skrūvēm, ja nepieciešams.
Gadījumā, ja jūs neesat pārliecināts par jebkuriem šo produktu montāžas un stiprinājumu aspektiem, lūdzu, konsultēties ar speciālistu

lt **SVARBU!**
Jūsų plazminis TV, LCD, LED televizorius, projektorius, projektorius ekranas ar kita HiFi įranga turi didelę vertę.
Jei varžtai yra komplekte, jie gali netikti pas Jus panaudotoms sienų, lubų ar grindų medžiagoms.
Pakeiskite varžtus į tinkamus, jei reikia.
Jei nesate tikras dėl bet kurio šio produkto montavimo aspekto- prašome kreiptis į profesionalus.

ro **IMPORTANT!**
Plasma ta, LCD, TV, proiector, ecran de proiectie sau alte echipamente HiFi reprezintă o valoare considerabilă.
În cazul în care suruburile sunt incluse ele nu pot fi potrivite pentru materialul peretelui dvs., tavan sau podea.
Remontați suruburile cu cele adecvate, dacă este necesar.
În cazul în care nu sunteți sigur cu privire la orice aspecte ale montării acestui produs vă rugăm să consultați un profesionist.

ru **ВНИМАНИЕ!**
Каким бы оборудованием HiFi вы ни пользовались, будь то плазменный, ЖК или стандартный телевизор, проектор или проекционный экран, - все они представляют значительную ценность. Не всегда крепления, прилагаемые в комплекте, подходят к материалу ваших стен, потолка или пола. При необходимости замените их на более подходящие.
Если у вас есть какие-либо сомнения относительно того, как крепить данный продукт, пожалуйста, проконсультируйтесь у квалифицированного специалиста.

sv **VIKTIG!**
Din plasmaskärm, LCD-skärm, TV, projektor, projektorskärm eller annan HiFi-utrustning representerar ett anseeligt värde. Om skruvar medföljer utrustningen är det inte säkert att de passar för materialet i väggen, taket eller golvet! Byt ut skruvarna mot lämpliga skruvar om så krävs. Kontakta en expert om du är osäker på något i samband med monteringen av produkten.

sk **DŔLEŽITĚ!**
Váš plazmový alebo LCD televizor, projektor, plátno a ďalšie elektrotechnické vybavenie je vysoko hodnotné.
Pokiaľ sú súčasťou balenia produktu skrutky, skontrolujte, či sú vhodné pre upevnenie k stene, stropu alebo podlahe v mieste inštalácie.
V prípade, že nebudú pribalené skrutky vyhovovať, vymeňte ich.
Pokiaľ budete mať pri montáži produktu potiaže, obráťte sa na skúseného odborníka

sl **POMEMBNO!**
Vaš Plasma, LCD, TV, projektor, projekcijsko platno ali drugo HiFi oprema predstavlja pomembno vrednost.
Če so vključeni vijaki ne smejo biti primerni za material svojega steno, strop ali tla.
Ponovno namestite vijake z ustreznimi tiste, če je potrebno.
V primeru, da ste prepričani o vseh vidikih vgradnje tega izdelka se obrnite na strokovnjaka.

tr **ÖNEMLİ!**
Plazma, LCD, TV, Projektör, Projektör Ekranını veya diğer HiFi cihazınızı son derece değerlidir. Birlikte verilen vidalar duvar, tavan veya döşeme teçizatınıza uygun olmayabilir. Gerektiğinde vidaları uygun olanlarla değiştirin.
Bu ürünün monte şekilleri ile ilgili sorunlarınız olması halinde bir uzmandan yardım alın.

zh **重要提示!**
您的等离子、LCD、TV、投影机、投影机屏幕或其它HiFi设备都有着不菲的价值。如果附带有螺钉它们可能不适合您的墙壁、天花板或地板。如果需要请将螺钉更换为适当的型号。
如果对本产品安装的任何方面有疑问请咨询专业人士。

**Warning!**

Always check the depth of the holes before starting an installation.

تحذير

الحرص دائماً عمق الثقوب قبل أن تبدأ في عملية التركيب.

ADVARSEL!

Kontroller altid hullernes dybde, før du går i gang med en installation.

WARNUNG!

Vor Beginn des Einbaus immer die Tiefe der Bohrungen überprüfen.

ΠΡΟΕΙΔΟΠΟΙΗΣΗ!

Ελέγχετε πάντοτε το βάθος των οπών προτού ξεκινήσετε την εγκατάσταση.

WARNING!

Always check the depth of the holes before starting an installation.

¡AVISO!

Controle siempre la profundidad de los agujeros antes de iniciar una instalación.

VAROITUS!

Selvitä reikien syvyys ennen asentamisen aloittamista.

ATTENTION !

Vérifiez toujours la profondeur des trous avant de commencer l'installation.

ATTENZIONE!

Verificare sempre la profondità dei fori prima dell'installazione.

Varováním!

Před začátkem instalace vždy zkontrolujte potřebnou hloubku všech otvorů.

ADVARSEL!

Sjekk alltid hvor dype hullene er før du begynner å montere.

OSTRZEŻENIE!

Przed przystąpieniem do montażu należy koniecznie sprawdzić głębokość otworów.

ПРЕДУПРЕЖДЕНИЕ!

Перед установкой всегда проверяйте глубину отверстий.

WARNING!

Kontrollera alltid hålens djup innan en installation påbörjas.

UYARI!

Montaja başlamadan önce daima deliklerin derinliğini kontrol edin.

警告!

请始终在安装前检查孔洞的深度。

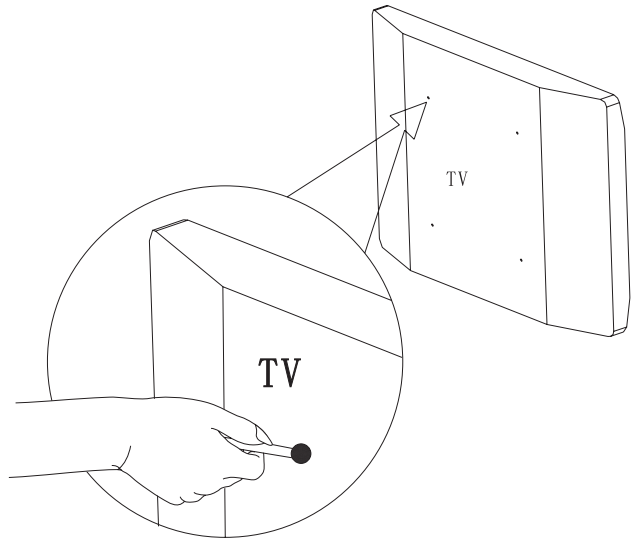
**WARRANTY CARD**

MULTIBRACKETS.COM

MULTIBRACKETS™ Limited Warranty

Multibrackets warrants its products to be free of defects in material and workmanship for the product's Warranty Period. The Warranty Period commences on the original purchase date of the product.

All Multibrackets products are covered by a limited product warranty:

- FIVE (5) years for metal video monitor mounts; all racks and non-electrical rack accessories
- TWO (2) years for gaslifts and sit-stand workstations
- ONE (1) year for all motorized and/or automated products, plastic speaker mounts; all speaker stands; all furniture; all wood (MDF) accessories

For warranty claims made during the Warranty Period, MULTIBRACKETS will replace any defective product part free of charge. Should a part on your Multibrackets product fail, please create an RMA case on www.multibrackets.com/support to make a warranty claim. We will await your documentation and then discuss the problem with you and once we confirm the product is under warranty, we will ship replacement parts to you. This Limited Warranty does not cover the costs of removing and replacing defective parts from your Multibrackets product. So, if your problem requires a repair technician, you must pay any labor charges.

This Limited Warranty extends only to the original purchaser of the product and is automatically void if your Multibrackets product is modified in any way, improperly installed, taxed beyond its stated weight capacity or otherwise misused or abused. All Multibrackets products are intended for indoor use only and any

outdoor use voids this Limited Warranty. The Limited Warranty for wall and ceiling mounts is void if the mount is moved from its initial installation. To the maximum extent permitted by applicable law, Multibrackets disclaims any other warranties, express or implied, including warranties of fitness for a particular purpose and warranties of merchantability. Multibrackets will not be liable for any damages whatsoever arising out of the use or inability to use its products, even if Multibrackets has been advised of the possibility of such damages. To the maximum extent permitted by applicable law, Multibrackets disclaims any responsibility for incidental or consequential damages.

Multibrackets™ Stockholm Sweden 2016.
www.multibrackets.com

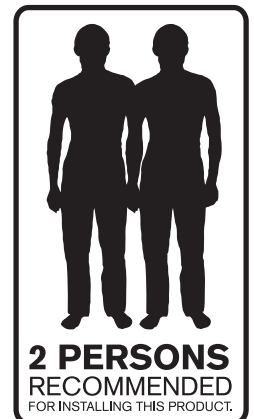



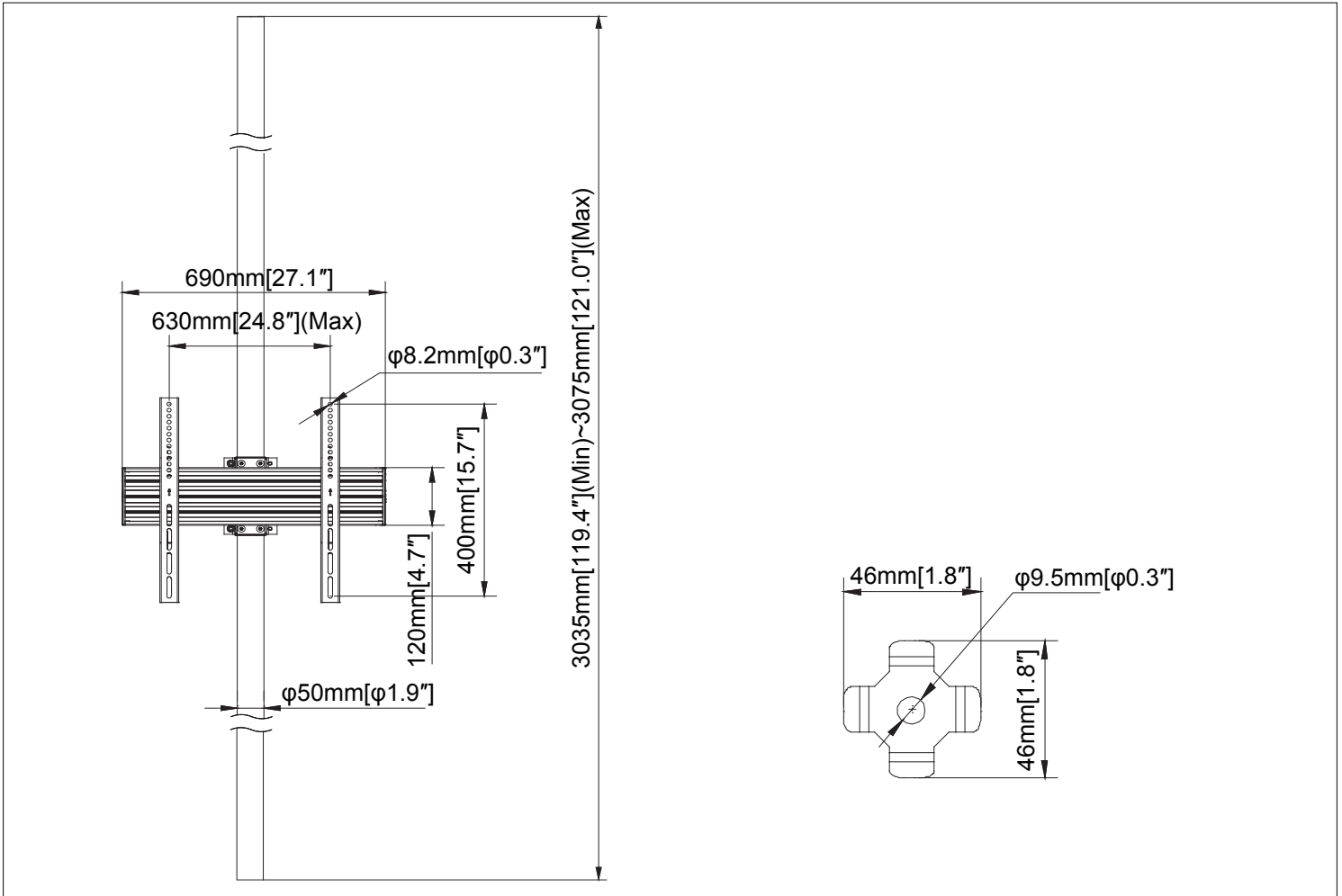

2 PERSONS
RECOMMENDED
FOR INSTALLING THIS PRODUCT.





Dimensions





COMPONENT CHECKLIST

M5X15  X4 A1	M6X15  X4 A2	M8X15  X4 A3	Ø16XØ6.2X1.5  X4 A4
--	--	--	---



X1



Open-wrench  X1 B1	5mm  X1 B2	6mm  X1 B3	M8x10  X4 B4	M8  X4 B5
--	--	---	--	---

X1

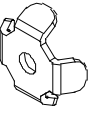
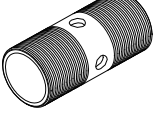
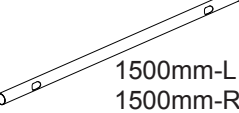
Ø16XØ8.2X1.5  X2 C1	Lag bolt  X2 C2	Anchor  X2 C3
---	---	---

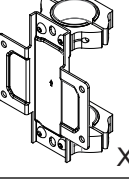
X1

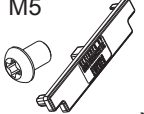
 X2 AA	 X1 BB	 1500mm-L 1500mm-R X2 CC	 400F X2 DD	 X1 EE
---	---	---	---	---

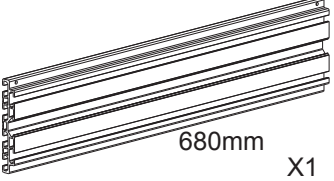
 M5 X2 FF	 X2 GG	 680mm X1 HH
---	---	---

Optional Tool (Does not include in the box)

The tool for drilling new holes
when extension pipe has been cut.

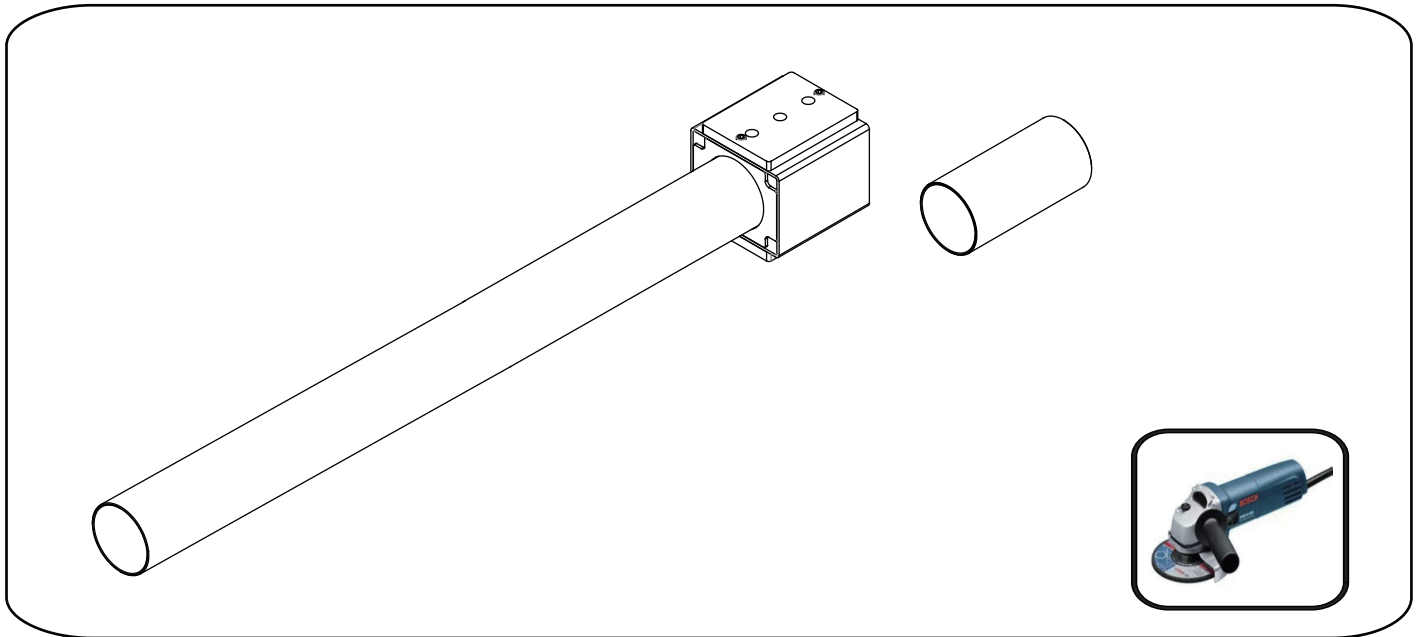
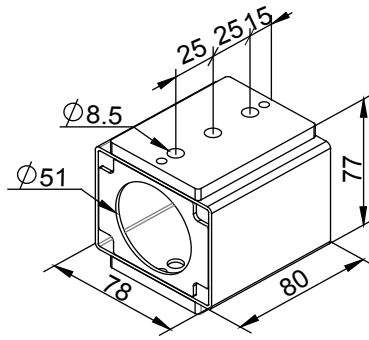
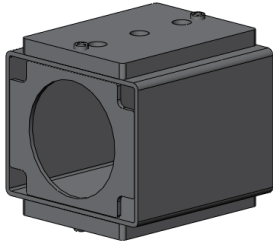

Installation Instructions

